

Varenummer: 23020344519

Beskrivelse: E+G Fingregreb MBT.50 p-M10x20-C9, Sort

Mål

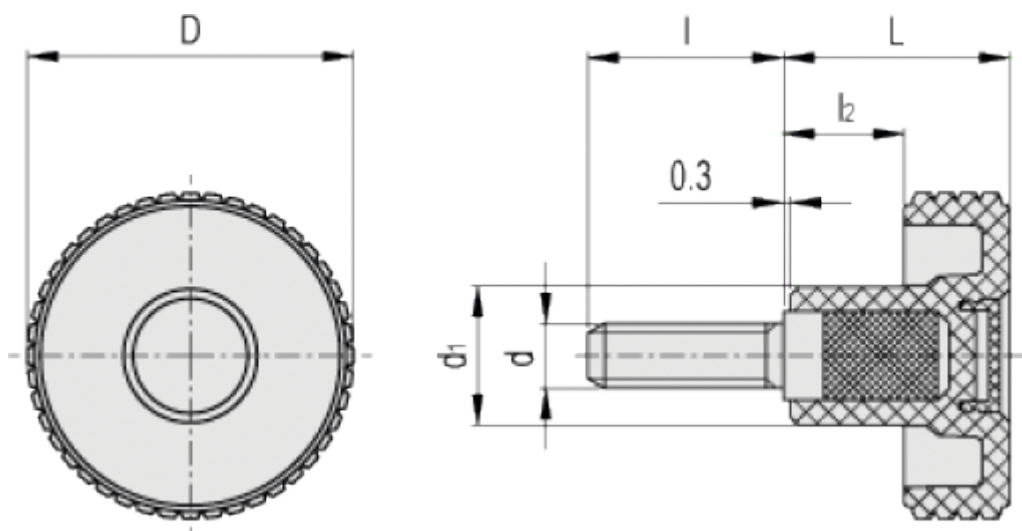

D	= 50
d1	= 20
d6g	= M10
L	= 33
l	= 20
l2	= 16